

Installation manual

English

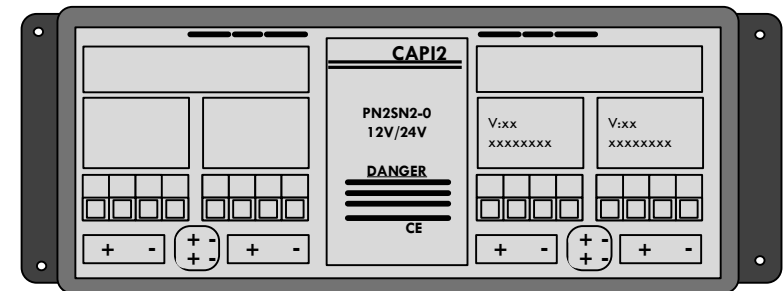

2 Power 2 Sensor Nodes

PN2SN2S-0

with screw connections

PN2SN2D-0

with Deutsch water tight plugg

Capi2 BV

Spegelt 29 ; 5674 CE Nuenen ; The Netherlands

www.capi2.com

26/05/2009 PU

Capi2 BV

Spegelt 29 ; 5674 CE Nuenen ; The Netherlands

www.capi2.com

General

The Capi2

Congratulations on purchasing a Capi2 bus power distribution system. The system can be assembled according to CE and ABYC standards. It is essential therefore to follow the installation instructions carefully.

Capi2 is a modern electronically controlled bus system. Special built in features reduce the risk of a cable fire or a low-voltage situation.

Features

Built in features in a complete Capi2 system includes:

- An electronic circuit breaker for each load. The circuit breaker can be reset with the push button panel.
- Visual and audible warnings.
- A warning for overloads. The appliance turns off automatically.
- A warning for low voltage. The appliance turns off automatically after a warning.
- A warning for wrong connected + and - power cable.
- Override fuse for each load
- Programmable:
 - Over load protection of 3/6/10 /13 Amp.
 - As a dimmer
 - For momentary switch.
 - For toggle switch
 - To be controlled by multiple switches.
 - To detect broken cable/lamp.
 - Recovery of essential equipment.
 - Timers.

Safety

About this manual

This user manual describes the installation of a **2 power- + 2 sensor Node** unite which is included in a Capi2 system. Read this manual carefully before installation or operation of the product. In case you have any doubt about a procedure contact your dealer.

General

Observe all safety instructions. Use this product only for the purpose it is intended for. Please contact your dealer immediately if a potential danger arises during the use of this product.

As used in this manual, the following signal words apply:

DANGER - indicates an imminently hazardous situation that, if not avoided, will result in death or serious injury.

WARNING - indicates a potentially hazardous situation that, if not avoided, could result in death or serious injury.

CAUTION - indicates a potentially hazardous situation that, if not avoided, may result in minor or moderate injury or property damage. It may also be used to alert against unsafe practices.

Modifications

Modifications to the product are not permitted.

Service and technical support

For information concerning specific settings, maintenance or repair work, contact your local dealer.

Example of a Capi2 installation

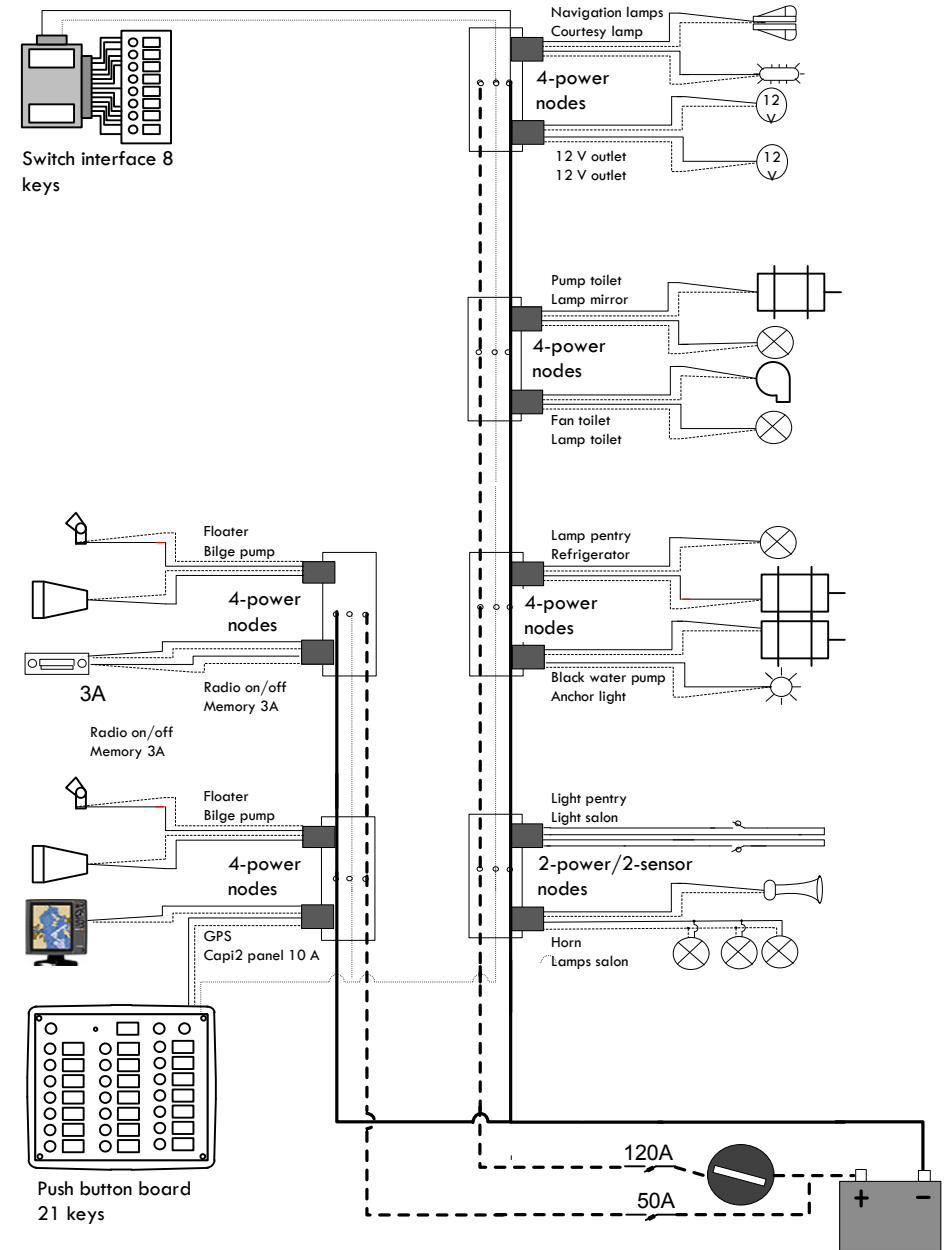

Two or more nodeunits.

Two or more node unite can be placed in serie.

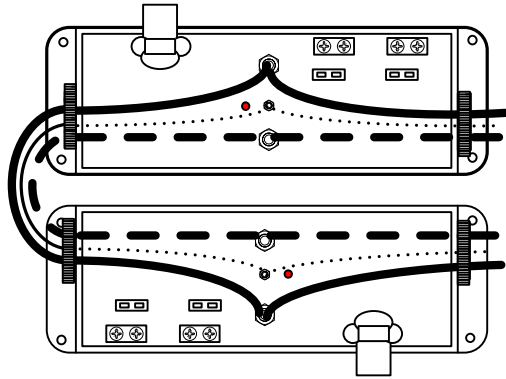

Testing the wiring of the system.

After all node unites have been connected to the loads and to the power, can the connections/ loads be tested for functionality We suggest that you do this before the configuration of the system.

- Turn on the battery connector. If the warning light **wrong polarity** (5b) is blinking you have to check if the + and - is correct connected, both at the battery and at the node.
- Check if the load receives power by placing a blade fuse in the override fuse holder(4b). Everything is correctly connected if the load is activated.
De-mount the fuse.
Do this procedure at all loads.

Advice

We advice you to make a list of all nodes with the following information.

- Location of node unite.
- Serial number node.
- Function of each node(to which load is the node connected)
- The Amperage you want to set (program) the node to.

If you make this list as you are testing the node unites then will the configuration of the system be a lot easier.

Mark the node unite

It is important that you mark up the Amperage you have programmed to the node unite.

A	3	6	10	16
m				
p			X	

Mark also on the comment place (1 a) to which load the node is connected.



Caution

Override fuses essential equipment.

Equipment such as bilge pumps and VHF has according to CE/ABYC regulation to have an manual over ride .

Place for this type of equipemtn a thermal fuse with an on/off function, in the holder for the over ride fuse (4b).

For other functions you can store fuses in the slot (3a) or an other Locations.

Press out holes for the fuses

When you use a resetable fuse is it necessary to to press out a hole in the cover.



Warning

Maximum over ride fuse (4b) is 20A for a std. blade fuse and 10A for a thermo fuse.

Do not use fuse with higher value then the programmed value of the node.
If you fail to do so is it risk for fire incase of short circuit.

Serial numbers.

Each node has its own serial number. The serial numbers are marked on the cover. You therefore have to be sure to keep the right cover to the right node unite.

On the inside of the cover you can also find the node unites serial number.

Precautions

General

- Never install any components above batteries or fuel tanks.
- Never install components or cables near heat sources that may melt the insulation.
- Never expose components or cables to oil or grease.
- Never install components when there is a risk of exposure to water.
- Never use twist-on connectors. Always follow the requirements in ABYC Standard E-11 or ISO Standard 10133.

Tools

- Always use the correct tool for crimping terminal connectors.

Cable protection

- Always take the necessary precautions to protect the components and cables from damage.
- Always clamp the wires at least every 30 cm (12").
- Always use insulation barriers and covers to prevent a short circuit of exposed terminal connectors.
- Protect cables that pass bulkheads or structural members against damage by grommets or equivalent means.
- Protect components and wires with sheaths, conduits or equivalent means when there is a risk of physical damage.

Cable requirements

- All wires must be fire resistant, fine-stranded and meet applicable ABYC Standard E-11 or ISO Standard 10133 requirements.
- Always use the correct cable diameter and colour according ABYC Standard E-11 or ISO Standard 10133.

Label top cover

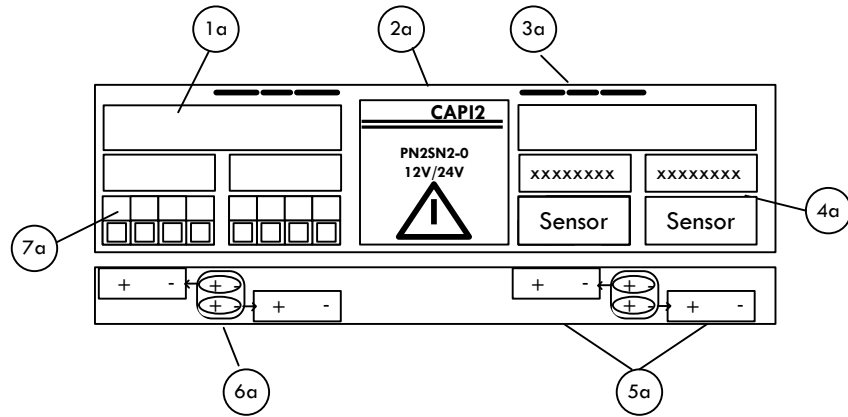

- 1a Comments.
- 2a Warning text.
- 3a Location of "Over ride fuses".
- 4a Serial number of the node.
- 5a Location of + and - on the screw connector.
- 6a Location of + and - in a Deutsch connector
- 7a Indication of amperage for the node

Label inside top cover

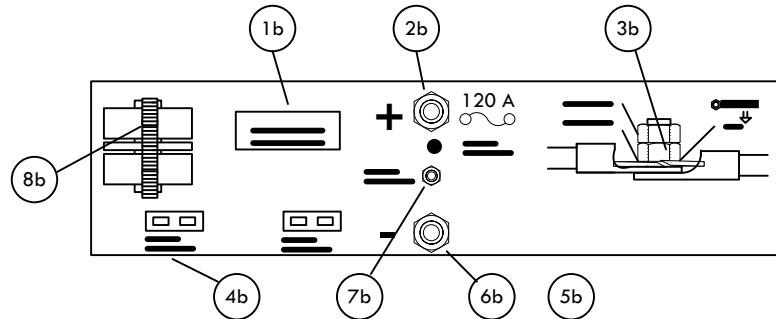

- 1b Product Serial number.
- 2b Screw connection and fuse value for incoming positive power cable.
- 3b Description of connection of the power cables.
- 4b Over ride fuse
- 5b Warning lamp for wrong polarity.
- 6b Screw connection of incoming negative power cable.
- 7b Screw connection of Capi2 bus cable.
- 8b Description of fastening of power cables.

De-mount the top cover.

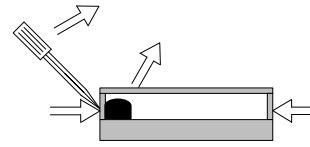

Mount the PN2SN2 node unite.

Use the four screw holes.

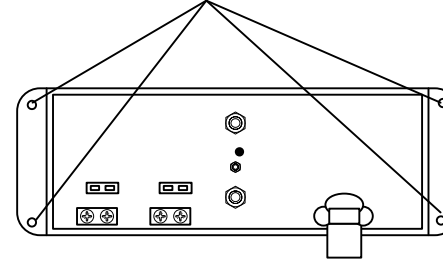

DANGER

This device is not ignition protected. Avoid serious injury or death from fire or explosion. Do not install in compartments containing gasoline (petrol) fueled engines or gasoline tanks, or in areas where ignition protected equipment is required.

Connect the loads to the different nodes.

This node unite has four separate nodes (N) which can be connected to single loads/switches or group of loads. There are either pre assembled plugs or screw connectors.

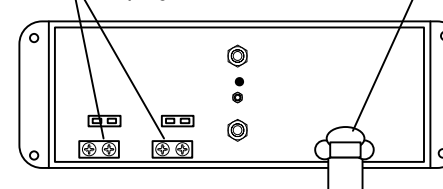

Connect the loads/switches

The positive and negative side correspond to the different nodes (as of drawing).

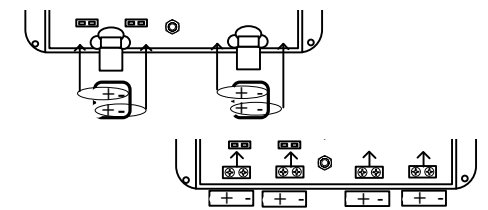

Warning

Use the right size and color of the cabling according to the ABYC and the CE regulations.

Connect the main feeders.

Connect the main feeders to the 6 mm screw connectors.

- Positive to (2b) and negative to (6b).
- The positive side has to be fused with 120 Ampere.

Connect the Capi2 bus to the 3 mm screw connector (7b).

Tighten up with tieraps as of (8b)

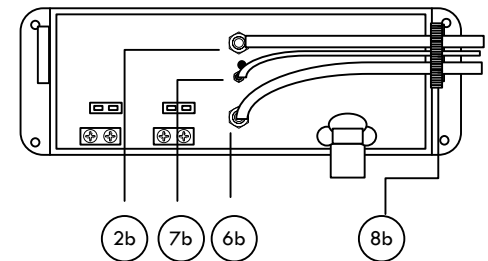

Place on each screw first the cable connectors then the washer (A) then the nut (B) tighten it with 3.4 Nm/30 in-lb. Place the second nut (C) and tighten it against nut (B).

